

Montageanweisung Viega Steptec

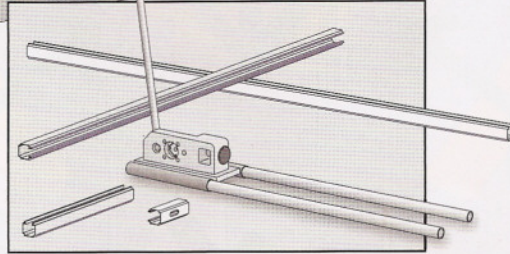

Viega StepTec

Achtung! Wichtiger Montagehinweis
Stützelement muss in der Schiene eingerastet sein.

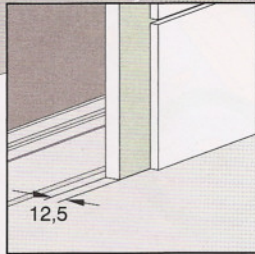
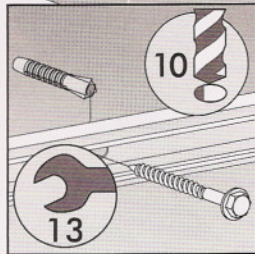
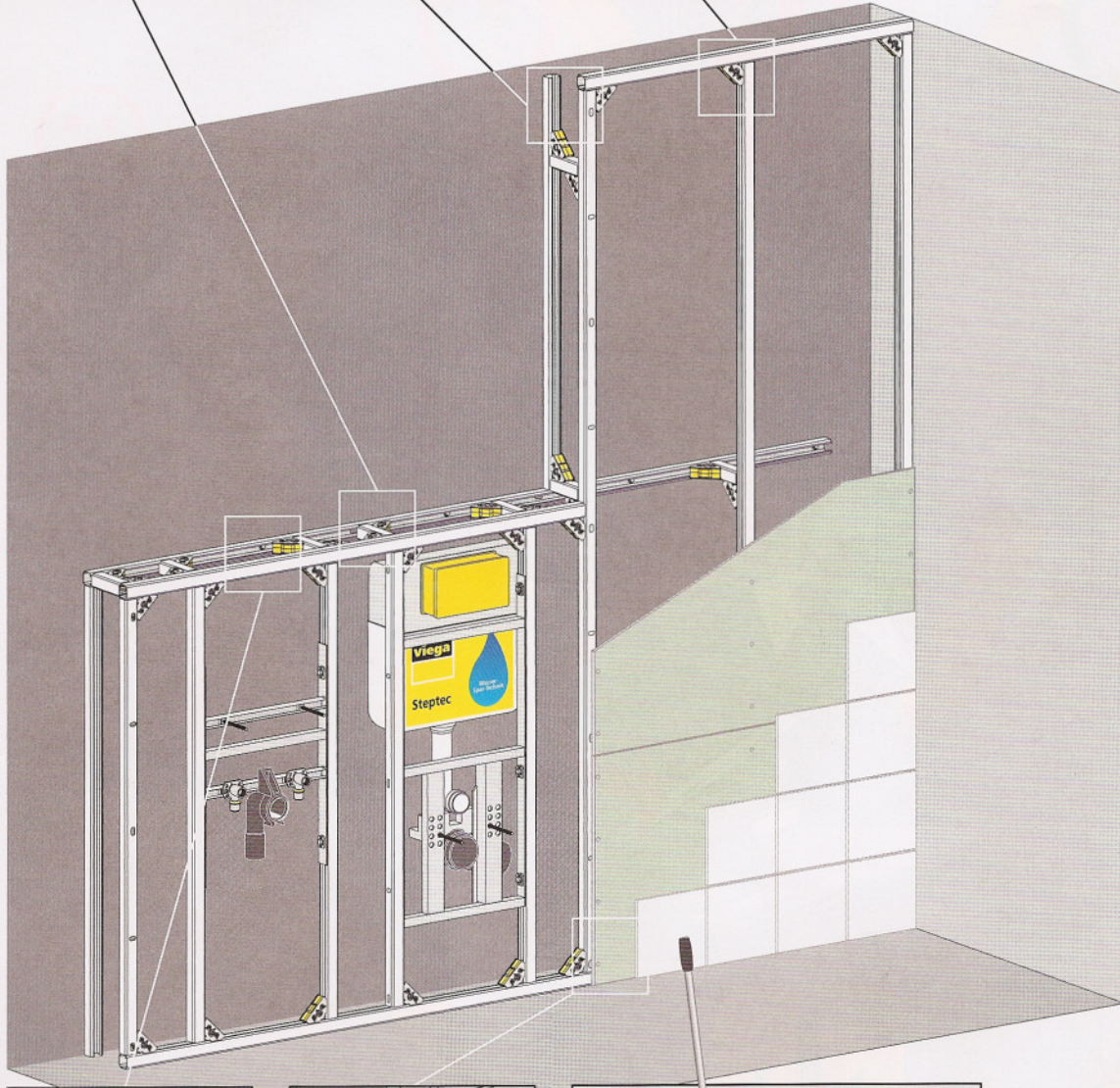
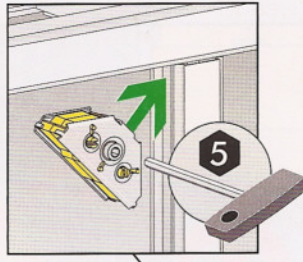
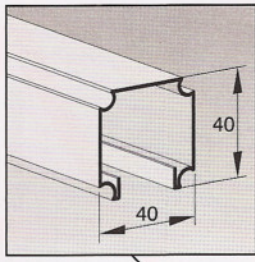
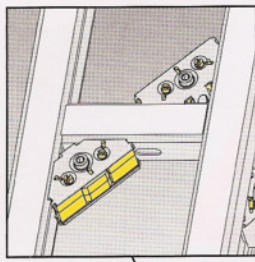
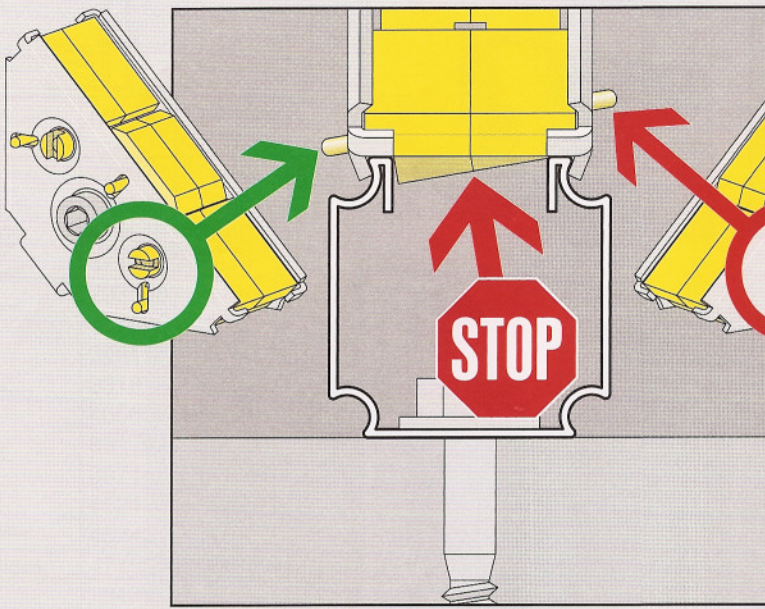

Wenn Zapfen oben,

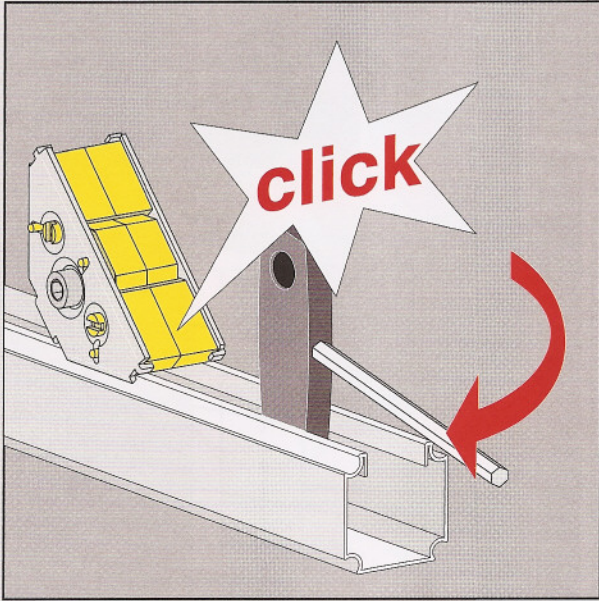

Schiene weiten.

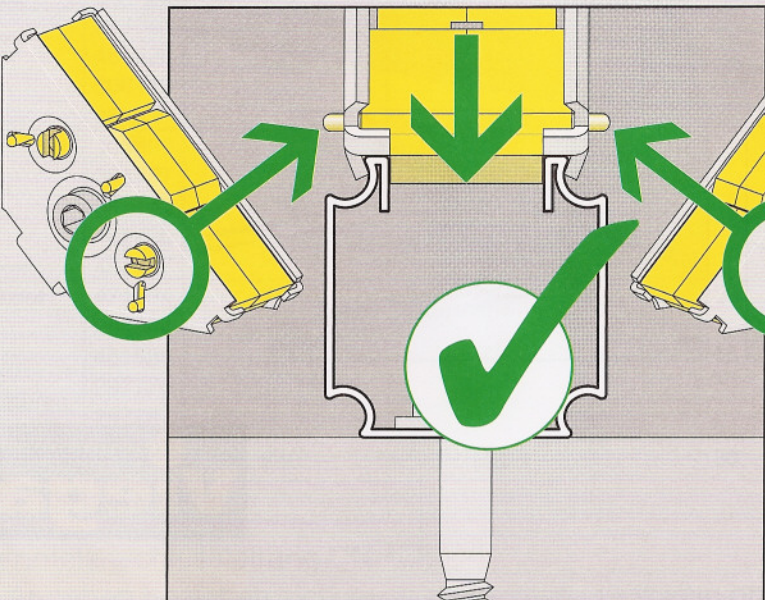

Beide Zapfen unten,



Festschrauben.

Viega Steptec

Verarbeitungsregeln (exemplarisch für Vorwand halbhoch)

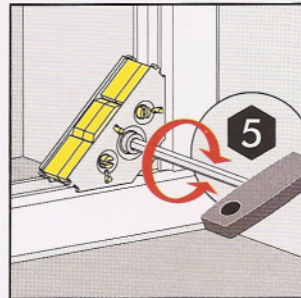
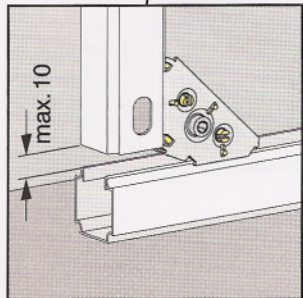
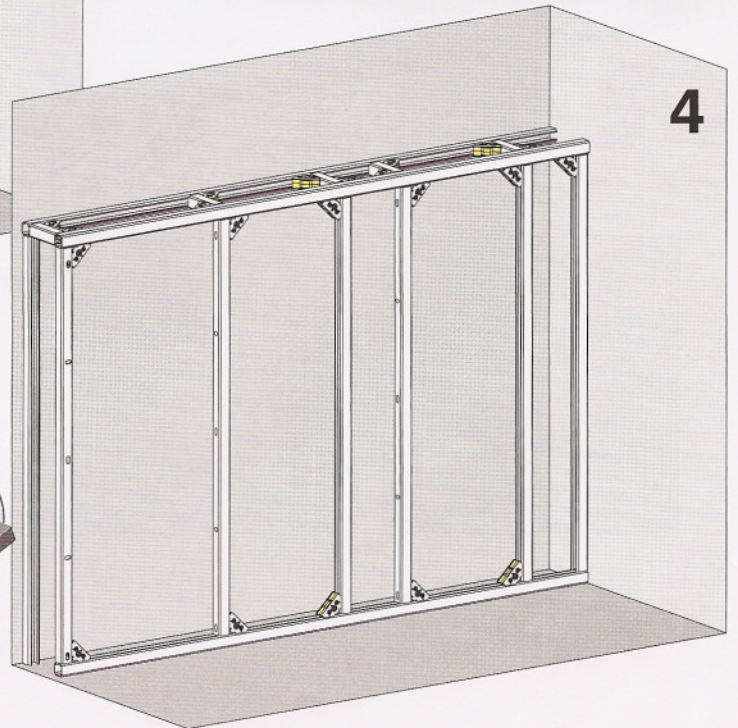
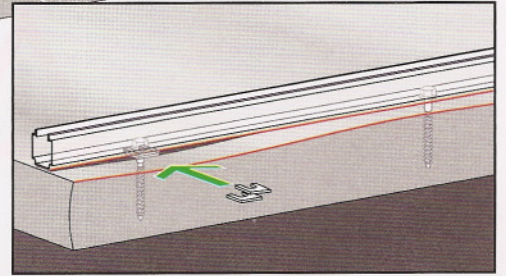
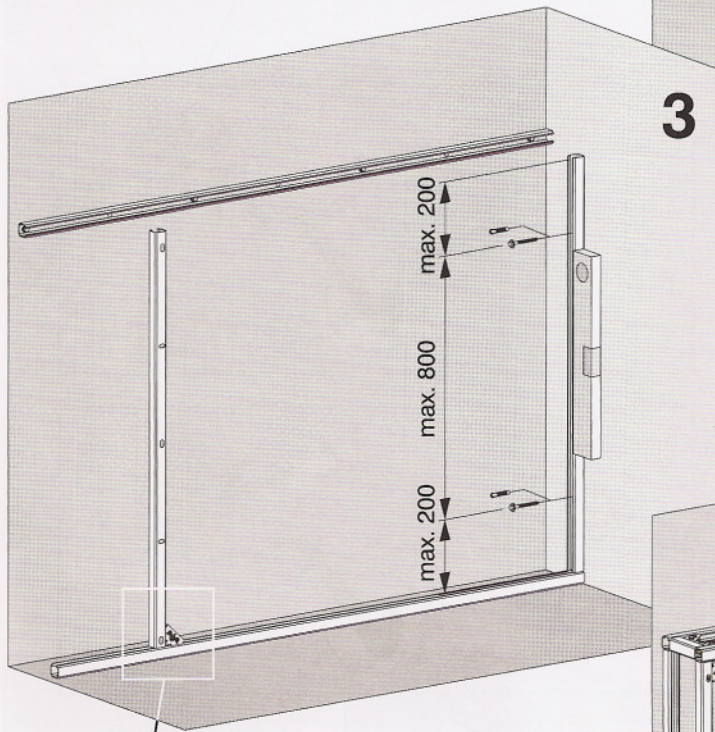
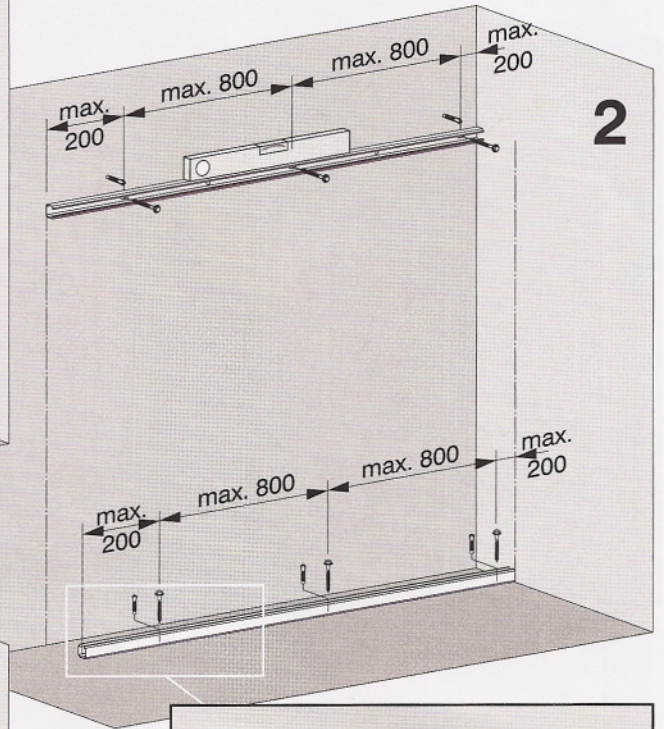
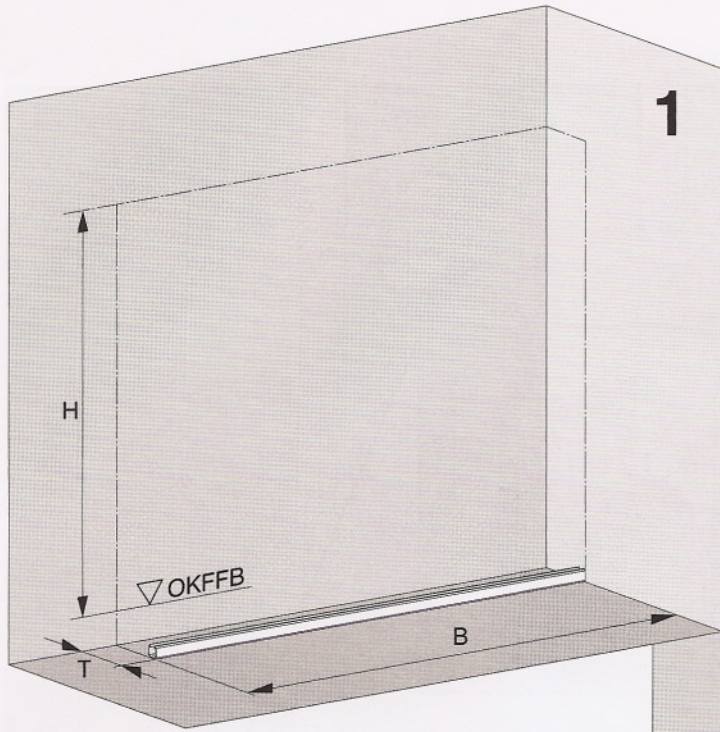

Viega Steptec

Verarbeitungsregeln

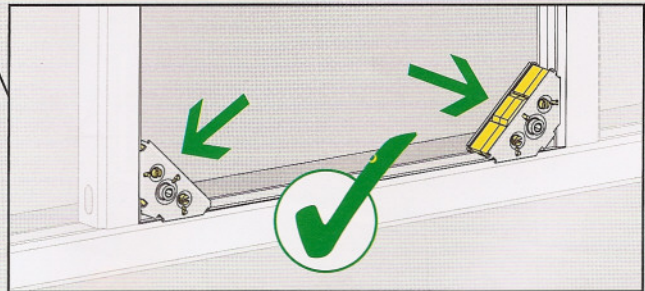
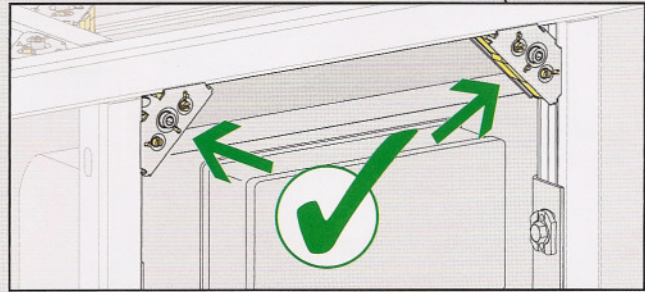
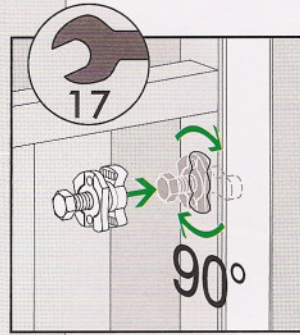
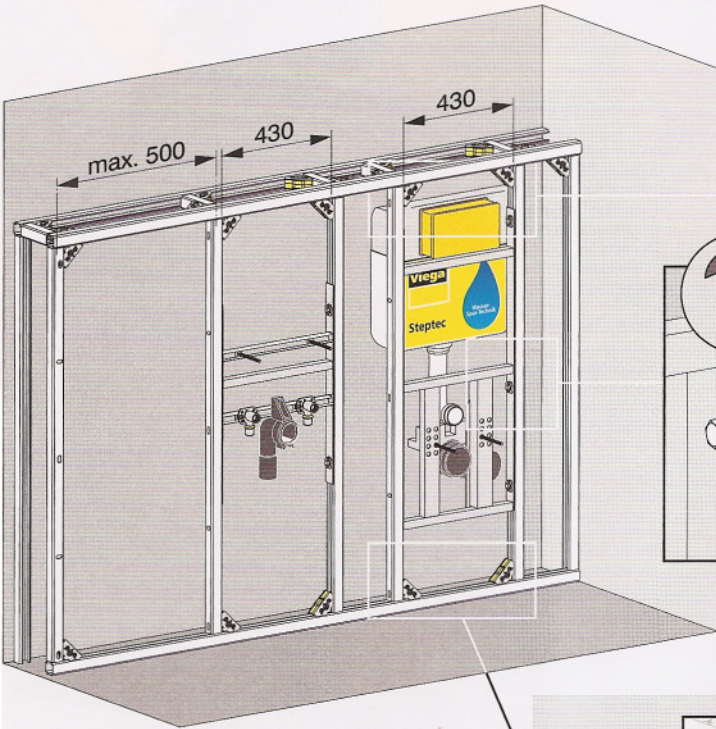

Viega Steptec

Verarbeitungsregeln

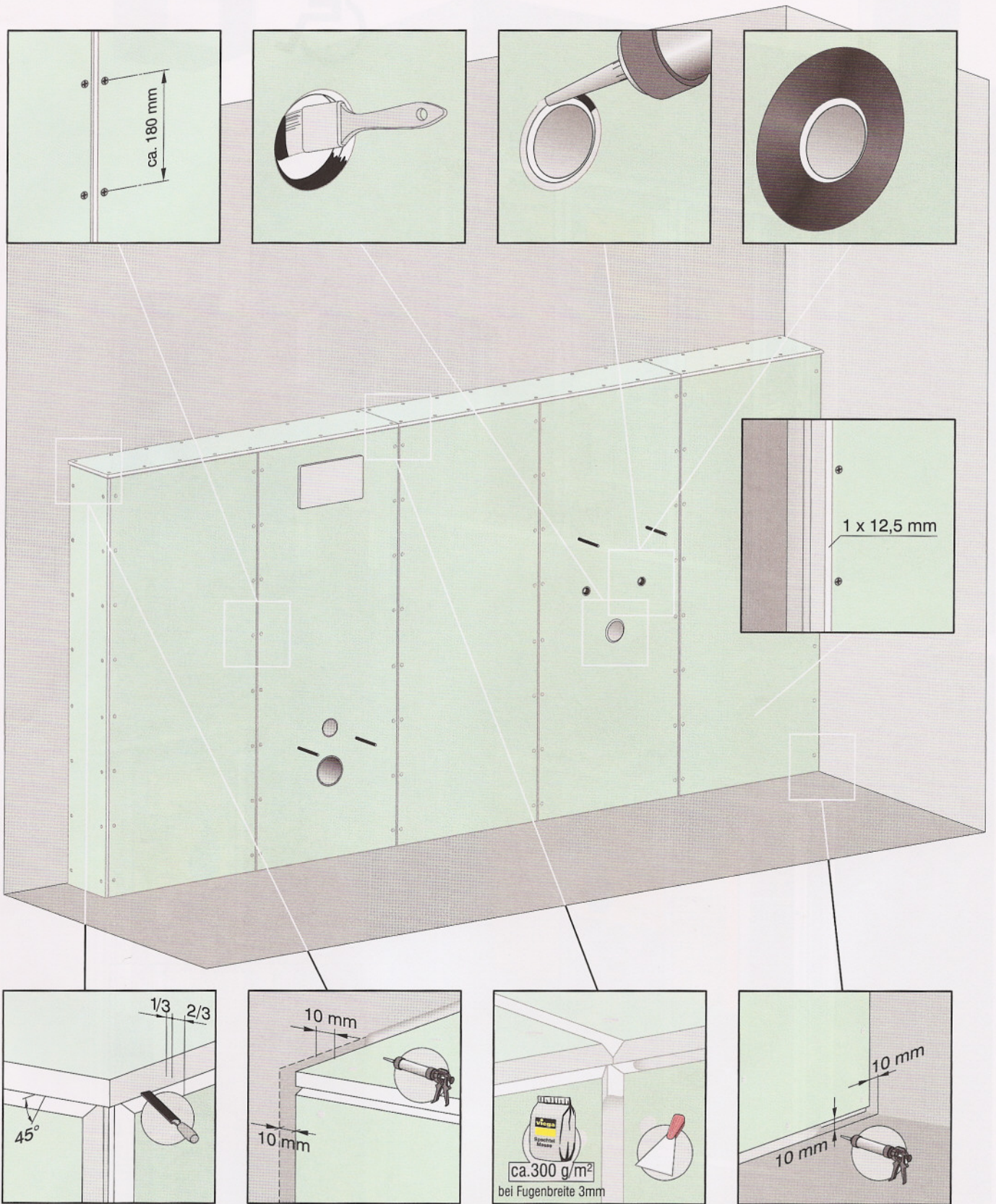

Senkrechte Stöße müssen hinterlegt sein!

Viega Steptec

Barrierefreie Montage

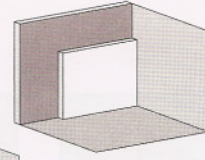

A

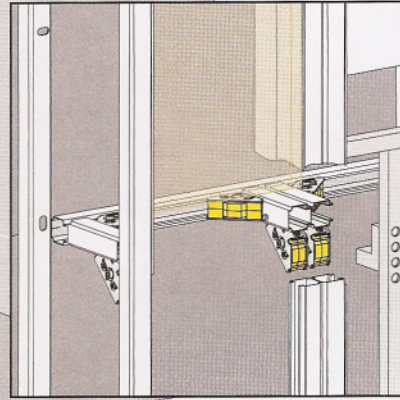
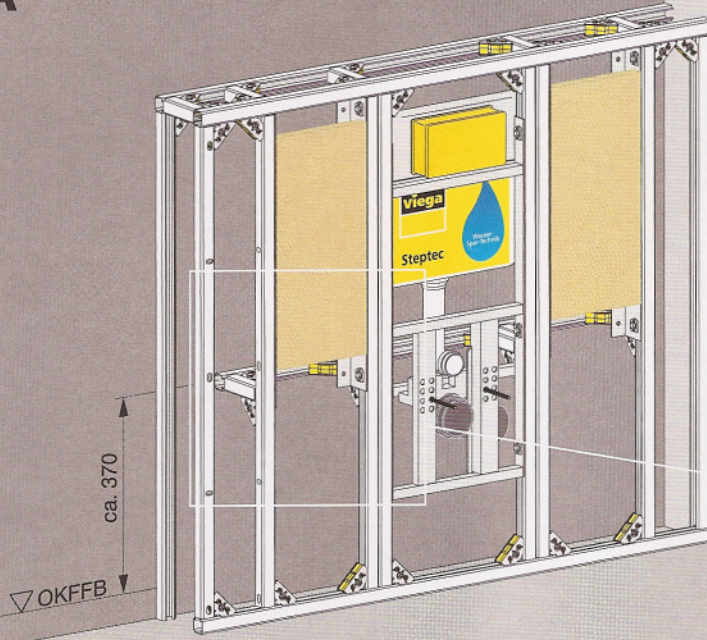

B

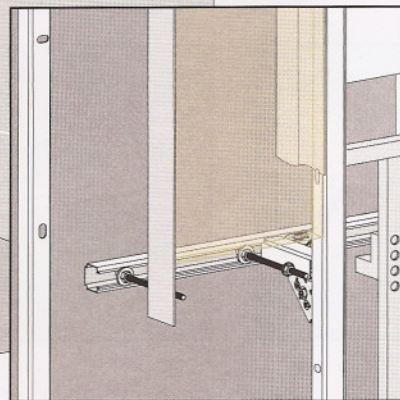
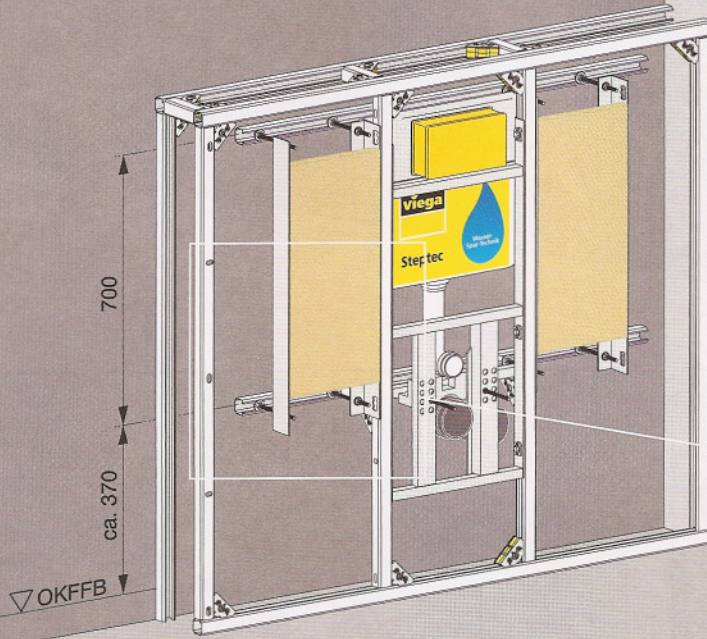

Viega Steptec

Eck-Montage

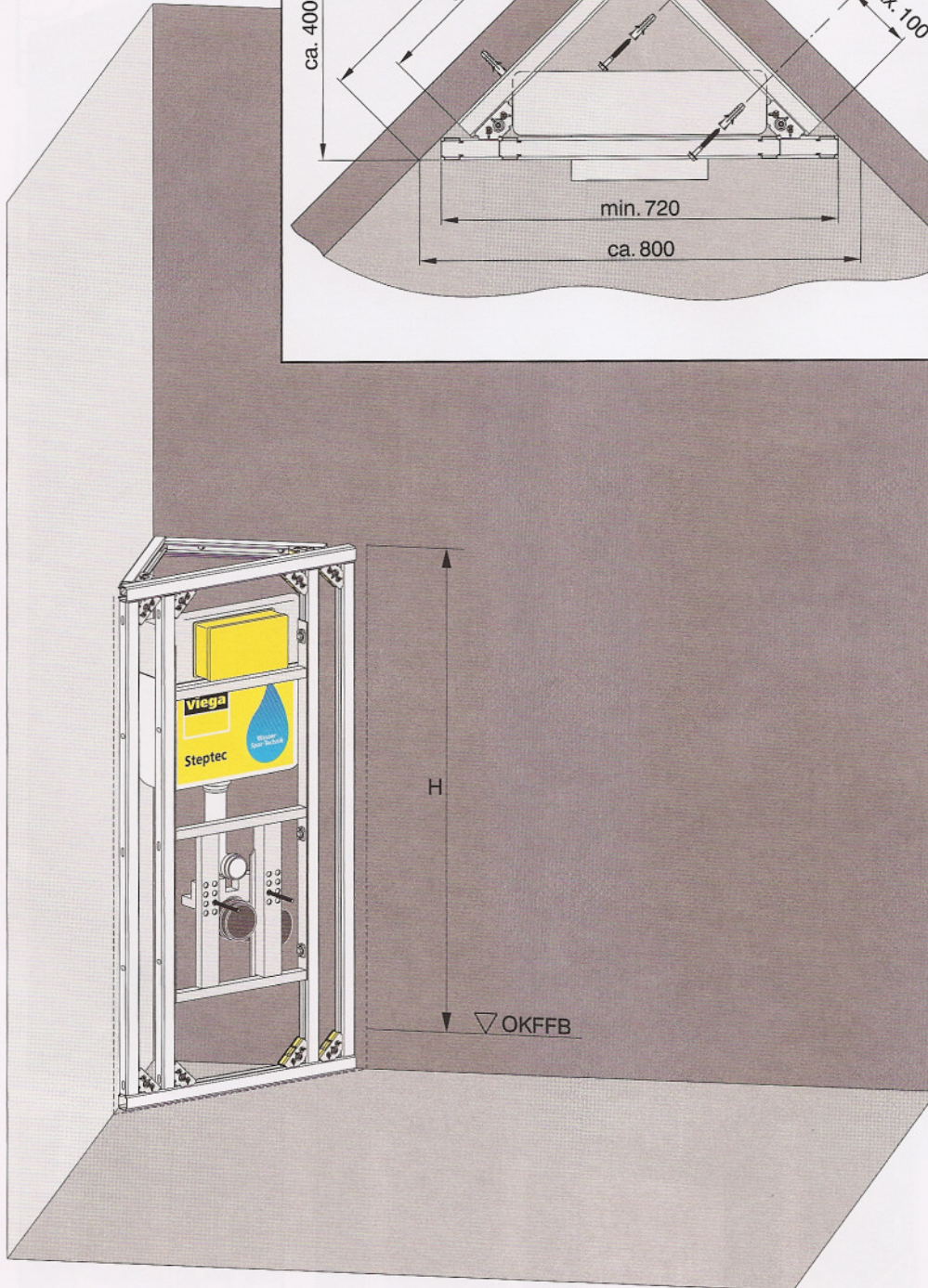
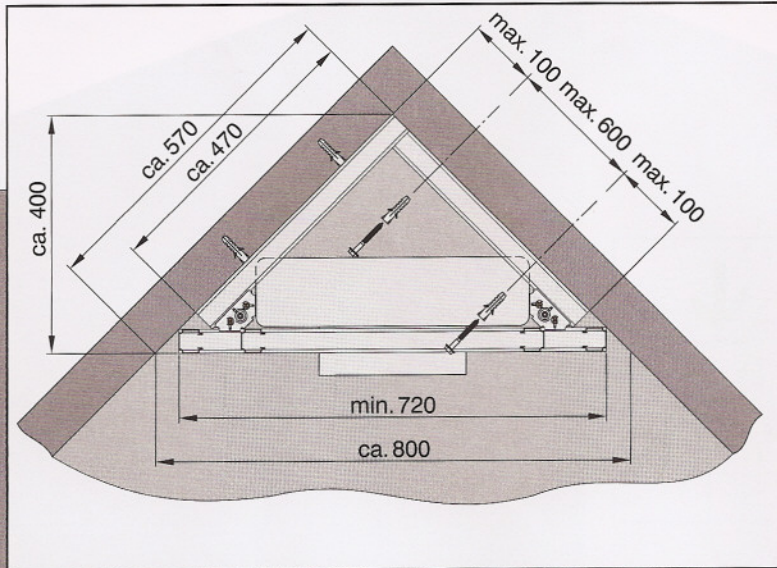
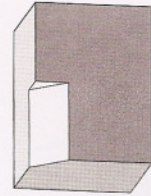

Viega Steptec

Raumteiler

Viega Steptec

Einbauelemente

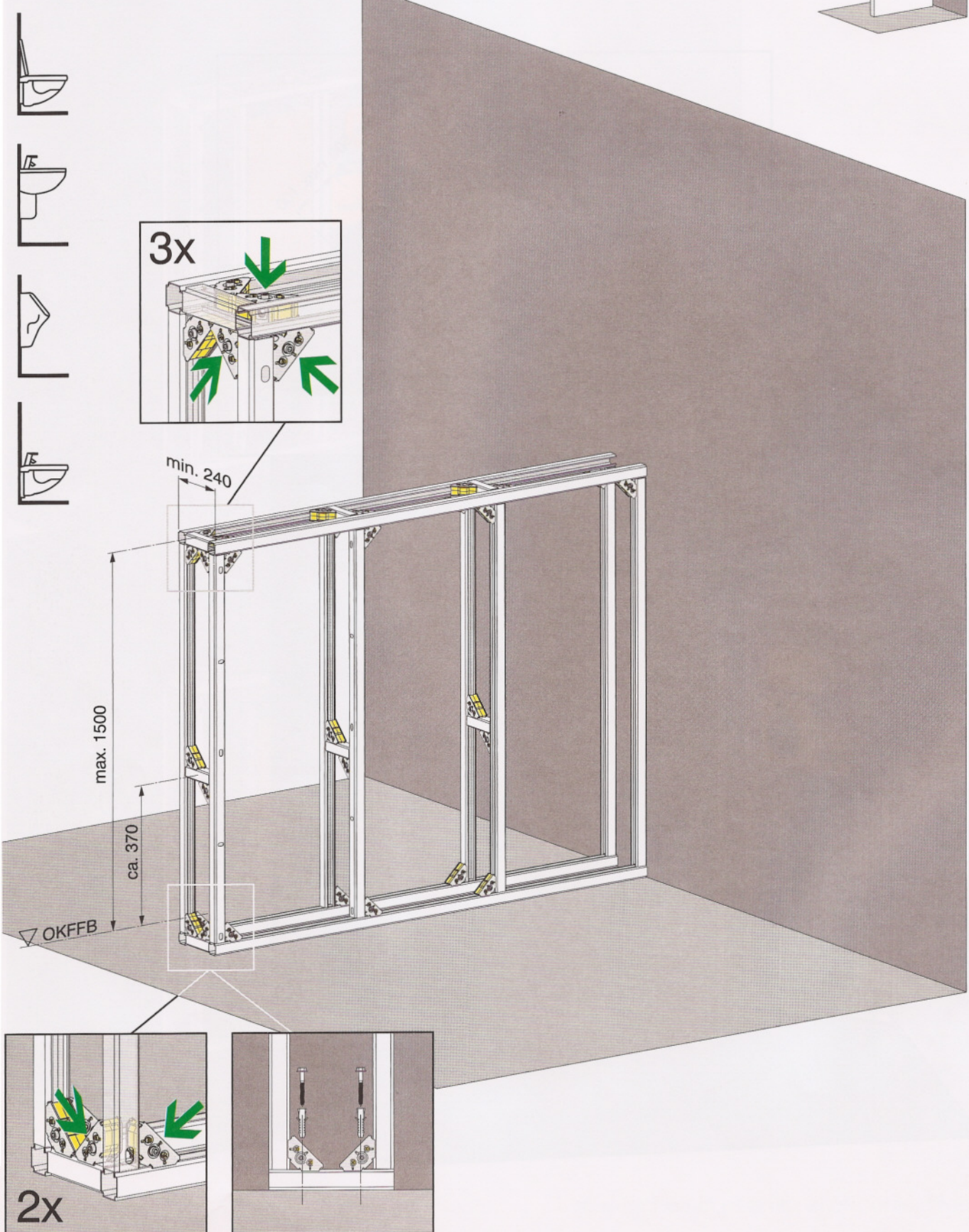

Viega Steptec

Raumteiler, freistehend

Viega Steptec
Raumteiler

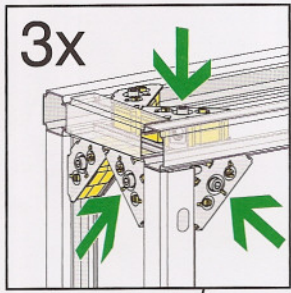

min. 240

max. 1500

ca. 370

OKFFB

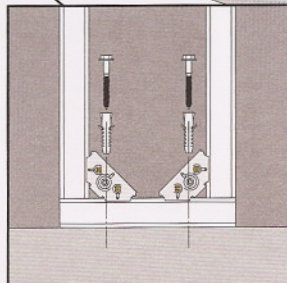
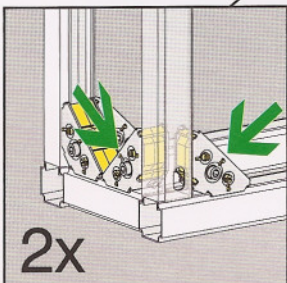

Viega Steptec

niedrige Bauhöhe

Viega Steptec
Raumhohe, feststehend

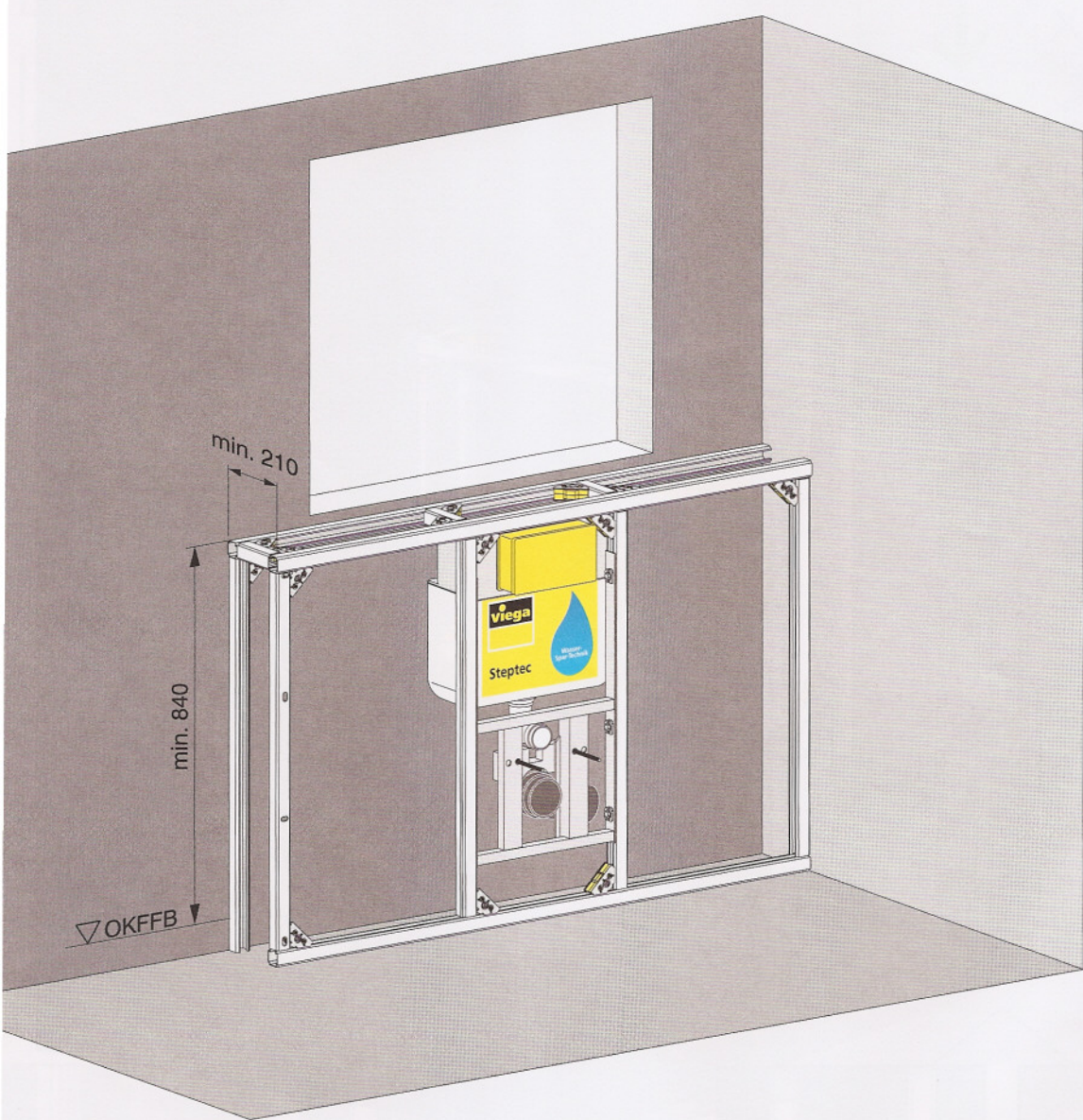
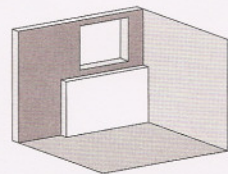

Viega Steptec

Vorwand, raumhoch

Viega Steptec

Vorwand

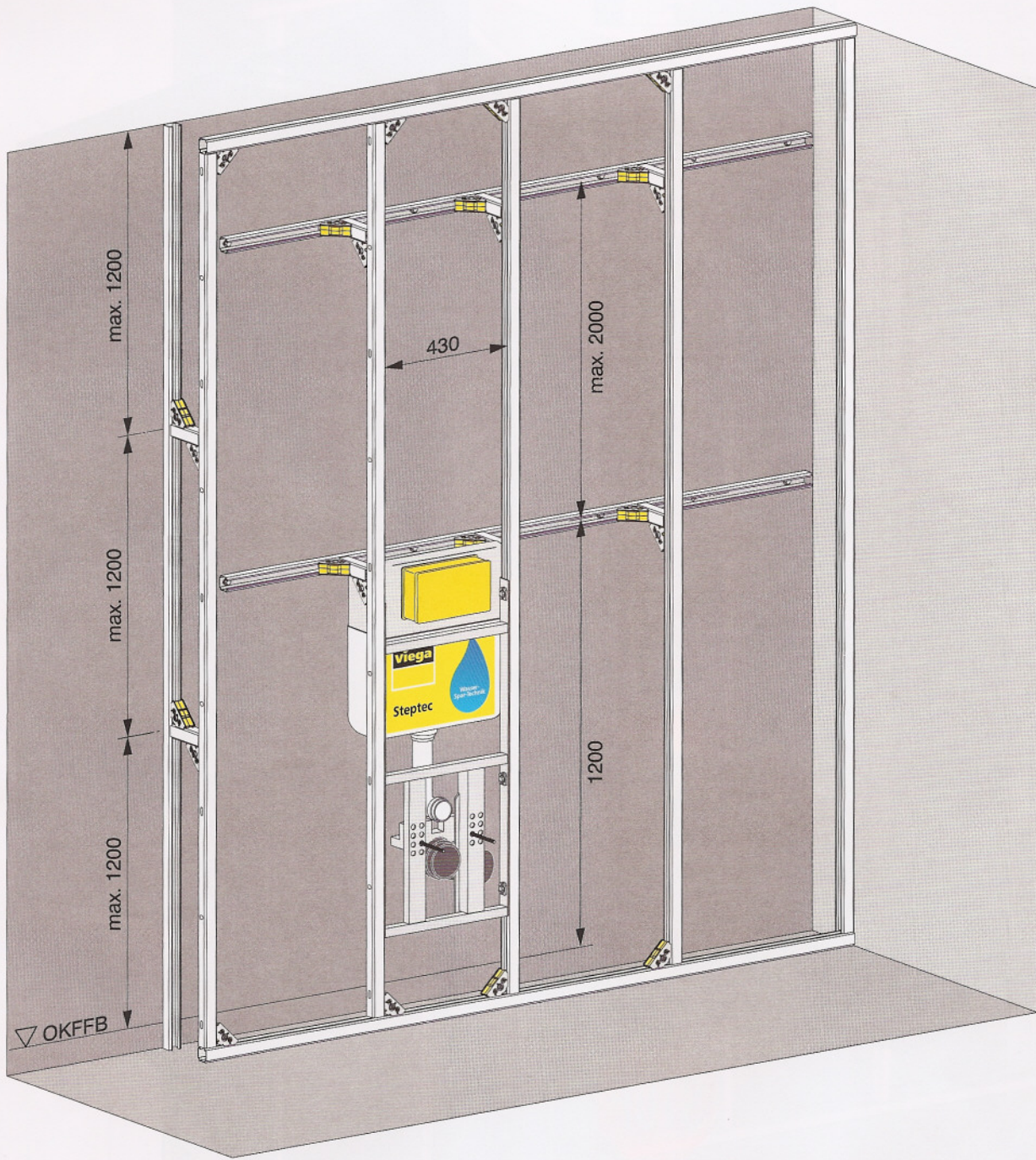
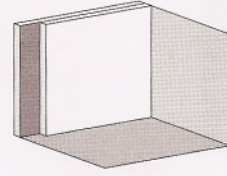

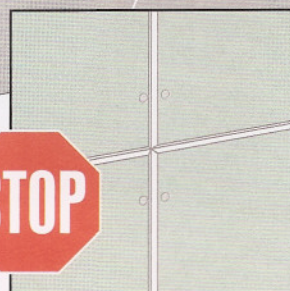
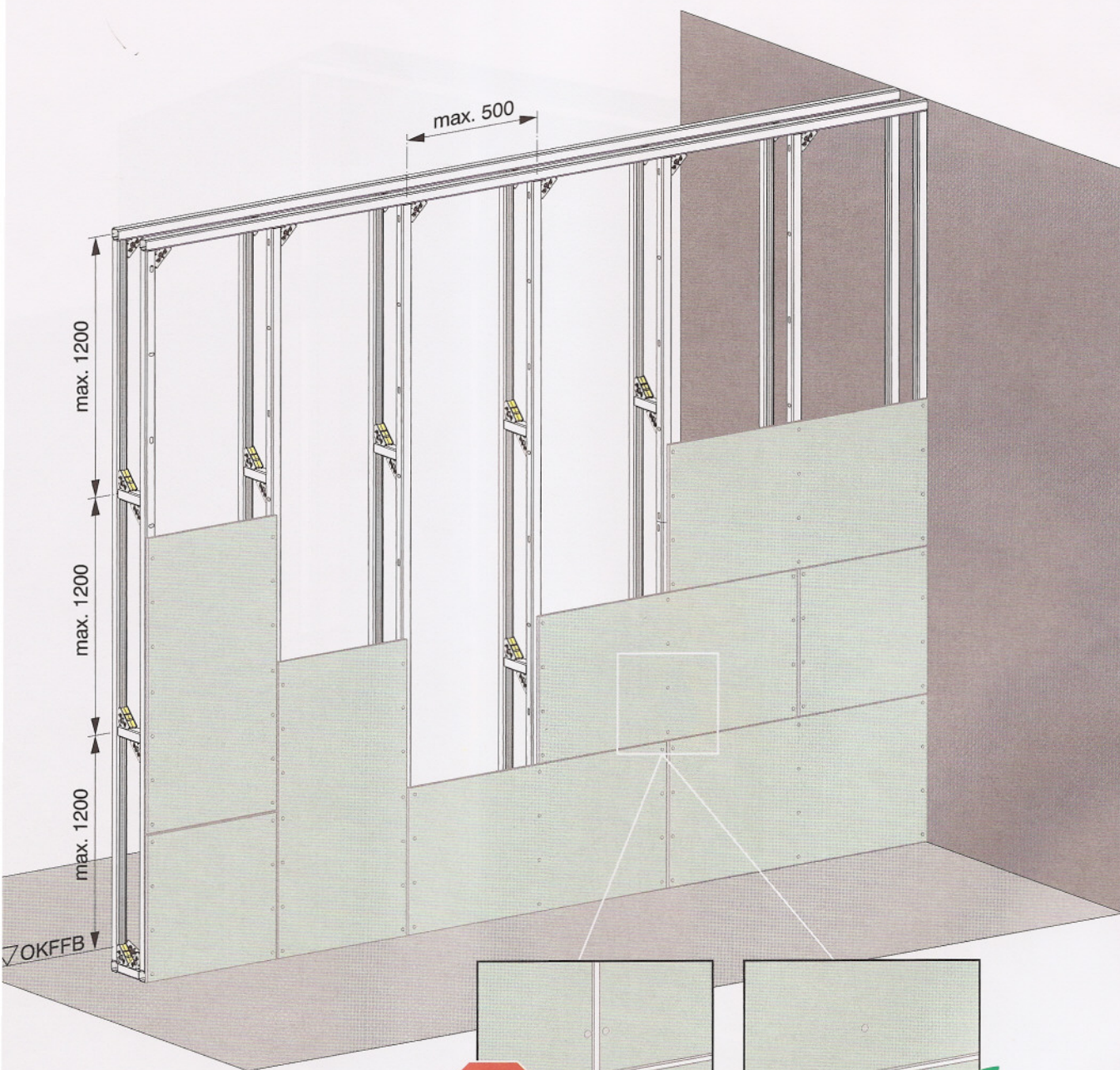
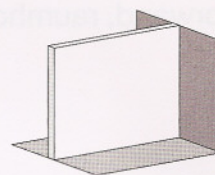

Viega Steptec

Vorwand an Dachschräge

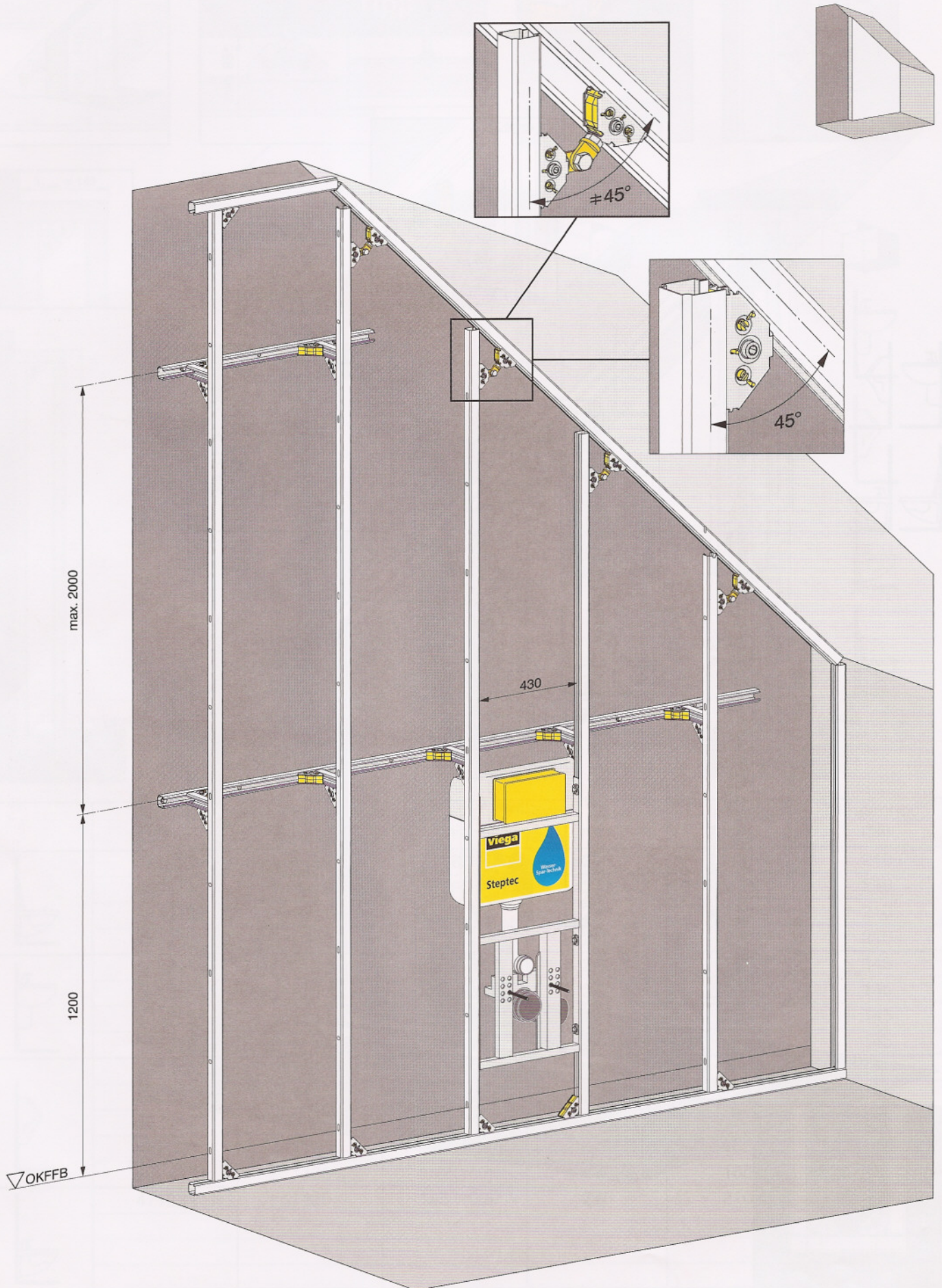

ega Steptec

innwand an Dachschräge

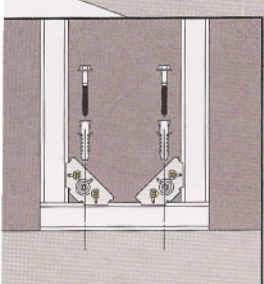
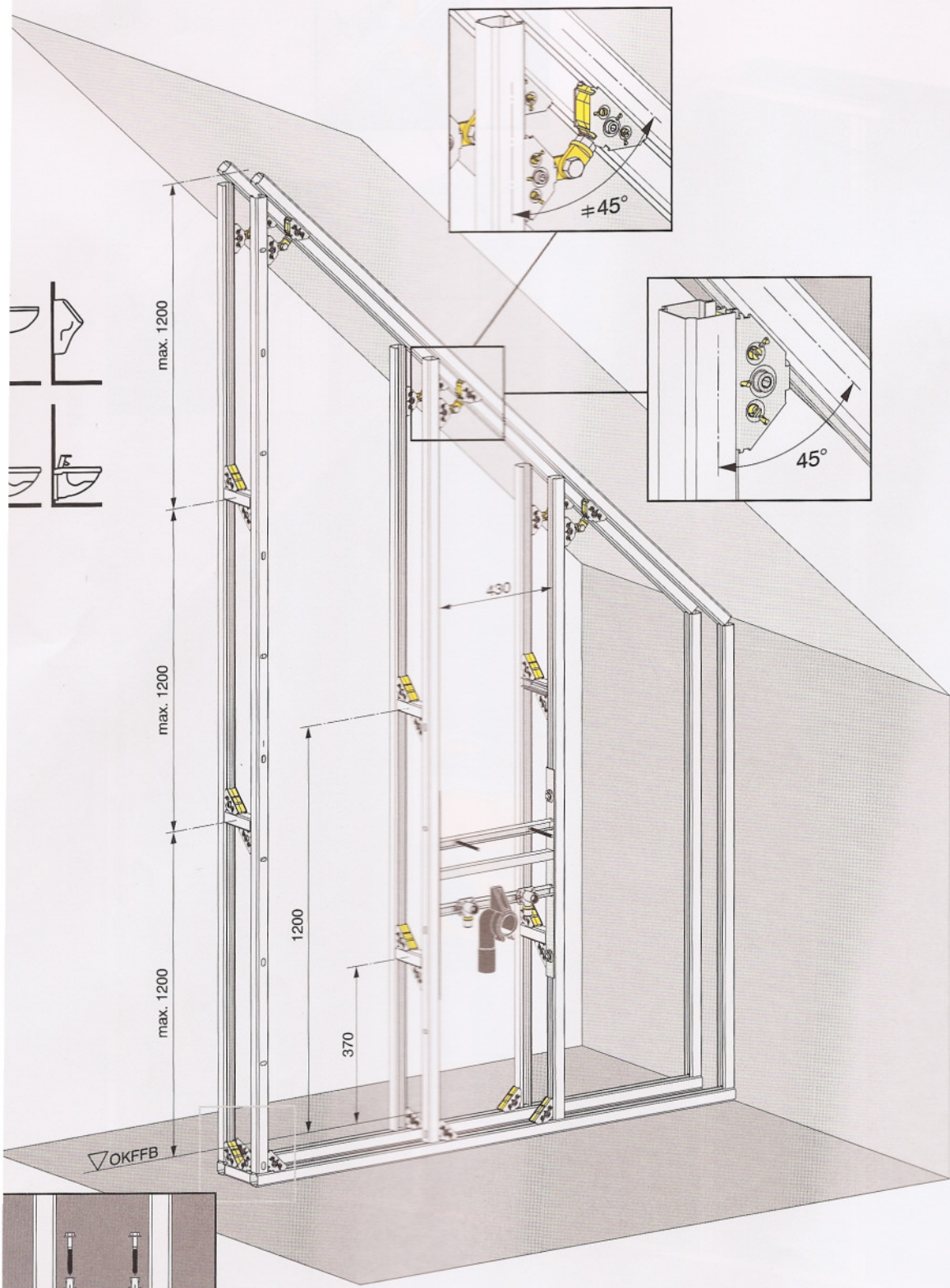
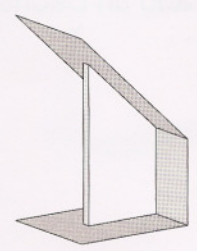

Viega StepTec

Einbaumaße

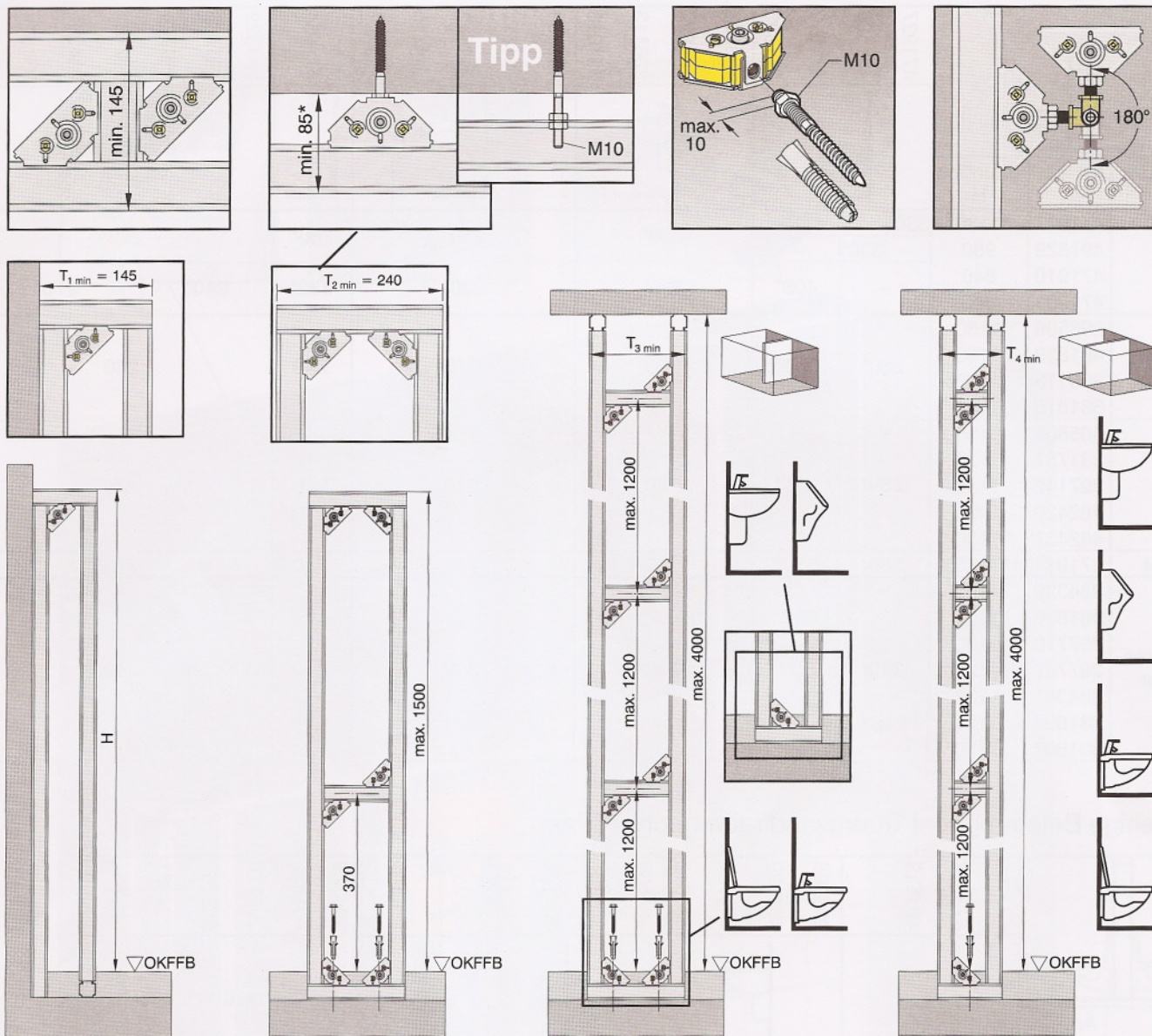

	Art.-Nr.	H Standard	T1 (*) min	T2 min	T3 raumhoch min	T4 raumhoch min
	471927	1130	165	240	210	210
	491529	980	165	240	210	210
	471910	840	200	240	210	210
	471903	840	200	240	210	210
	293598	1130	145 (85)	240	165	145
	461829	1130	145 (100)	240	165	145
	306113	1130	145 (100)	240	165	145
	331818	1130	145 (100)	240	165	145
	405809	1130	145 (100)	240	165	145
	331757	1130	145 (100)	240	165	145
	397142	1130	145 (100)	240	165	145
	462420	1130	145 (100)	240	165	145
	462437	1130	145 (100)	240	165	145
	471934	1130	145 (100)	240	210	145

Tiege Steptec

rennwand an Dachschräge

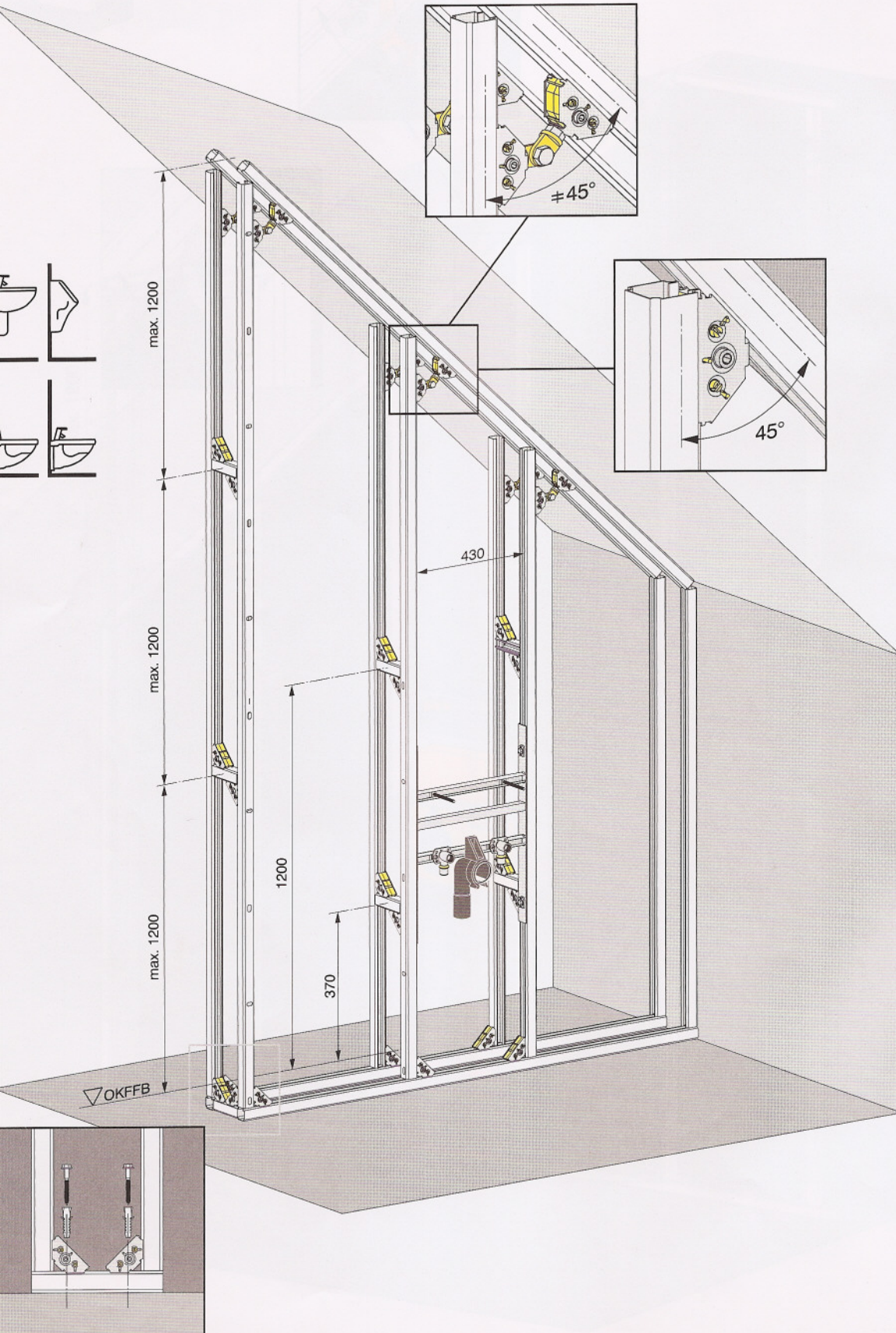



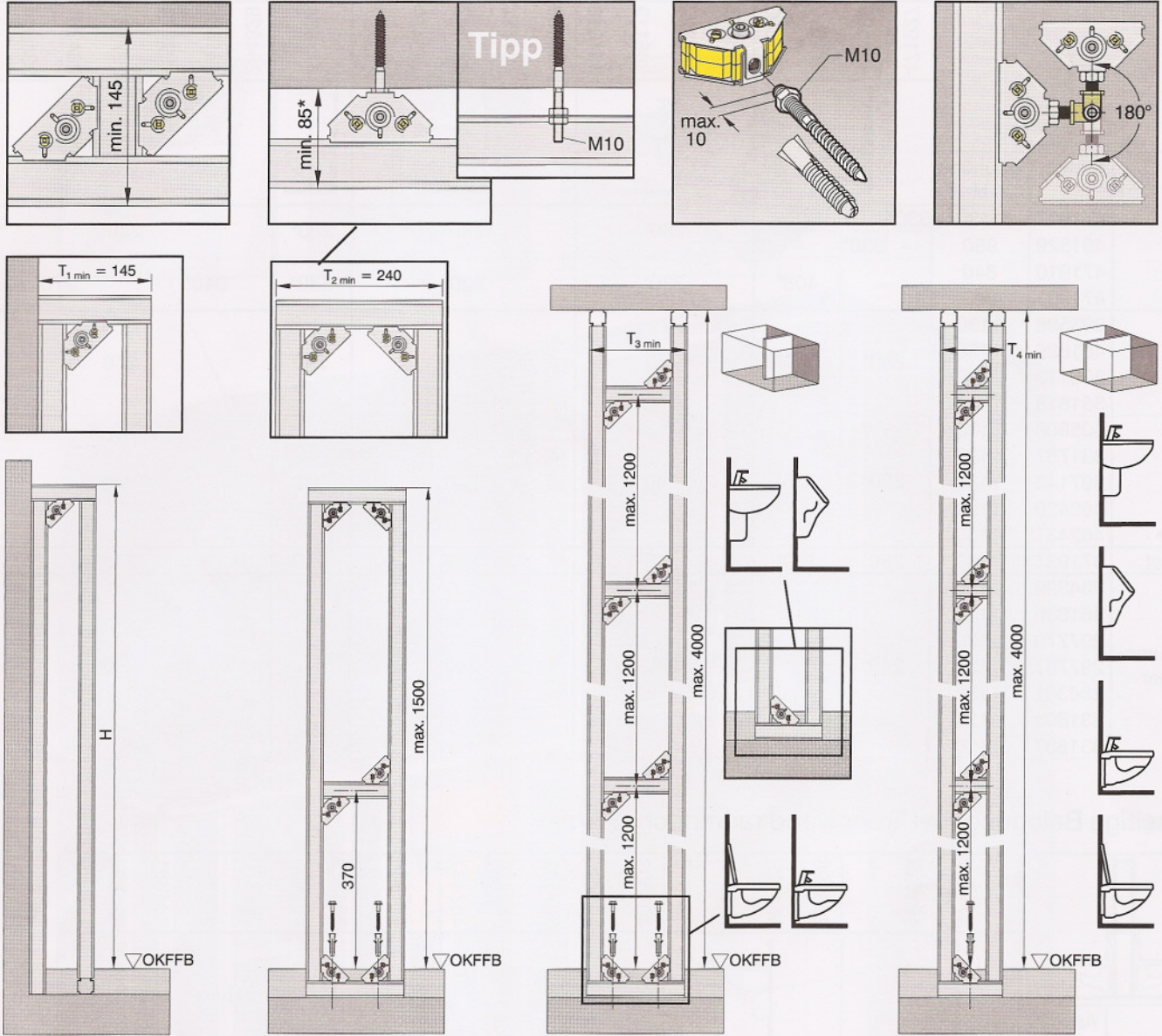

Viega Steptec

Einbaumaße



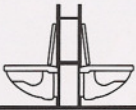



	Art.-Nr.	H Standard	T1 (*) min	T2 min	T3 raumhoch min	T4 raumhoch min
	471927	1130	165	240	210	210
	491529	980	165	240	210	210
	471910	840	200	240	210	210
	471903	840	200	240	210	210
	293598	1130	145 (85)	240	165	145
	461829	1130	145 (100)	240	165	145
	306113	1130	145 (100)	240	165	145
	331818	1130	145 (100)	240	165	145
	405809	1130	145 (100)	240	165	145
	331757	1130	145 (100)	240	165	145
	397142	1130	145 (100)	240	165	145
	462420	1130	145 (100)	240	165	145
	462437	1130	145 (100)	240	165	145
	471934	1130	145 (100)	240	210	145

seitige Belegung, bei Raumteiler halbhoch, T2 min

		471927	491529	471910	471903	293598	461829	306113	331818	405809	331757	397142	462420	462437	471934	284329	461836	297770	297787	284381	331894	331887
Art.-Nr.	Bauhöhe H					Armaturenträger																
471927	1130	330*	-			280*		280*		280*	240*											
491529	980	-	330*	-																		
471910	840			400*		330*		330*		330*	240*	270*										
471903	840	-																				
293598	1130																					
461829	1130	280*		330*		240		240		240	240											
306113	1130																					
331818	1130																					
405809	1130																					
331757	1130																					
397142	1130	280*		330*		240		240		240	240											
462420	1130																					
462437	1130																					
471934	1130	280*		330*		240		240		240	240											
284329	1130																					
461836	1130			240*																		
297770	1130																					
297787	1130	240*				240		240		240	240											
284381	1130																					
331894	1130			270*																		
331887	1130																					

seitige Belegung, bei Trennwand raumhoch, T3 min

		471927	491529	293598	461829	306113	331818	405809	331757	397142	462420	462437	471934	284329	461836	297770	297787	284381	331894	331887	
Art.-Nr.						Armaturenträger															
471927																					
491529		330*		280*					280*		280*		280*	220*	240*						
293598																					
461829																					
306113																					
331818																					
405809																					
331757																					
397142		280*		220					220		220		220	165	180						
462420																					
462437																					
471934		280*		220					220		220		220	165	180						
284329																					
461836		220*		165					165		165		165	165							
297770																					
297787																					
284381																					
331894		240*		180					180		180		180	165							
331887																					

Anmelanschlussleitung DN 100

Angaben beziehen sich auf Installationswandtiefen ohne Beplankung und Fliesen.